

MEI

VN Series Coin Changers

- ▶ VN 4000
- ▶ VN 4010XV
- ▶ VN 4510





General Information

Overview	2
Product Summary	2
Series 4000 Features	2
Model Number Configuration Comparison	2
Serial Number Configuration.....	3
Tube Cassette Options	3
Specifications	3
Available Interfaces	3

Installation

Unpacking the Changer	3
Warranty	4
Mounting the Changer	4
Switch Setting Configuration	6
Switch Settings	6
Loading the Cassette	8
Loading with the Float Up Feature	9
Placing the Cassette Back on the Changer	9
Manually Dispensing Coins	9
Testing the Changer	9

Operation

General Operation	10
Keypad Operation	10
Float Up	11
Float Down	11
Coin Teach	11
Token Teach Feature -- VN4510 Only	11
Coin Inhibit/Enable	12

Interfaces

General	12
MicroMech 110Vdc/24Vdc	12
MDB -- Multi-drop Bus	14

Maintenance

Cleaning	14
----------------	-----------

Diagnostics

General	15
Status LED	15
Diagnosing and repairing by LED Signals	16

Repair Policy

Owner's Responsibility	18
MEI's Responsibility	18
Service	18



Overview

The Series 4000 Operation and Service Guide contains important information on installing, operating, and maintaining Mars Electronics International Coin Changers models VN4000, VN4010XV and VN4510. The Series 4000 Coin Changers are perfect for busy, demanding applications where greater change capacity is a must. The flexibility of the 4 coin-tube cassette reduces "change starvation" and lowers the number of incidents with the "Exact Change" light, thus encouraging sales. It is also possible to dispense the dollar coin if your machine has the ability to accept \$5 bills.

Product Summary

The VN4000 model of the Series 4000 is designed for vending applications that require a 110V MicroMech coin changer. It has a 12-pin MicroMech plug and is a direct replacement for the 3-tube model TRC-6000.

The VN4010XV model of the Series 4000 is designed for vending applications that require a 24V MicroMech coin changer. It has a 15-pin MicroMech plug and is a direct replacement for the 3-tube model TRC-6010XV.

The VN4510 model of the Series 4000 is designed for vending applications that require a MDB (Multi-Drop Bus) coin changer. It has the standard 6-pin MDB plug and is a direct replacement for the 3-tube model TRC-6510/TRC-6512.

Series 4000 Features

- Four tubes for change payback (flexible)
- \$1 coin payout
- Diagnostic LED
- Advanced coin inventory control (float feature)
- 16 standard coin-tube configuration cassettes to satisfy most popular vend price scenarios
- Eliminates "forbidden" vend prices
- Greatly reduces need for a Dollar Bill Changer
- Designed for ease of maintenance
- Token Capability (MDB)

Note: Some Vending Machine Controllers require a software upgrade to recognize the fourth tube on the VN4000 changer. Check with the machine manufacturer before installing the unit.

Model Number Configuration Comparison

Model Number	Description	MEI's 3-tube Equivalent
VN4000	110V MicroMech Interface - 12 Pin	TRC-6000
VN4010XV	24V MicroMech interface - 15 Pin	TRC-6010XV
VN4510	MDB Interface	TRC-6510

Adapter Cable

If required, an adapter harness is available to allow a VN4010XV (which has a 15 pin connector) to connect to a 12 pin receptacle 24 volt machine. This harness is included in the kit part number 113749001.

Diagram: Adapter Cable

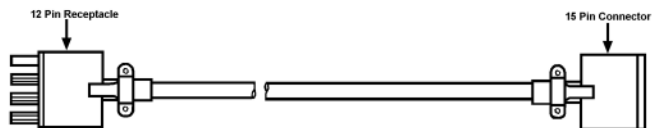



Serial Number Configuration

WWYLCCPPPP	
WW	-- Week manufactured (01 through 52)
Y	-- Year Manufactured (7 for 1997)
L	-- Manufacturing Location
CC	-- Configuration Code
PPPP	-- Sequential production number
For warranty, see page 4.	

Tube Cassette Options

The Series 4000 offers fifteen different cassette configurations. These are listed in the table below with their respective part numbers.

TUBE POSITION					
Description	A	B	C	D	MEI P/N
TC15	10¢	5¢	25¢	\$1	198132016
TC14	5¢	5¢	10¢	\$1	198134014
TC13	10¢	5¢	\$1	\$1	198136013
TC12	5¢	5¢	25¢	5¢	198138012
TC11	10¢	25¢	25¢	5¢	198130011
TC10	5¢	25¢	25¢	\$1	198132010
TC9	5¢	25¢	\$1	\$1	198137009
TC8	5¢	25¢	25¢	25¢	198139008
TC7	5¢	5¢	\$1	\$1	198131007
TC6	5¢	5¢	25¢	25¢	198133006
TC5	5¢	5¢	10¢	25¢	198135005
TC4	5¢	5¢	5¢	\$1	198137004
TC3	10¢	5¢	10¢	5¢	198139003
TC2	5¢	5¢	25¢	\$1	198131002
TC1	10¢	25¢	10¢	5¢	198133001

Specifications

Power

The Model VN4000 is available as a 115VDC (unfiltered) unit.
 The Model VN4010XV is available as a 24VDC (unfiltered) unit.
 The Model VN4510 is a 34VDC unit (MDB mode).

Power ratings for the units are:

- 110VDC / at 100 mA
- 24VDC / at 400 mA

UL Listing

The Series 4000 is listed under UL File # E57869.

Available Interfaces

The VN4000 and VN4010XV support the MicroMech interface.

The VN4510 supports the MDB interface.

See *Interfaces* on page 12 for a description of each type of interface.

Unpacking the Coin Changer

Unpack the coin changer and immediately inspect it for damage. If the unit is damaged, return it to its original carton along with packing materials.

- ▶ Notify the delivering carrier of damages and request immediate inspection. Send a letter of intent to file a claim to the delivering carrier within 72 hours from the time of delivery. Send a copy of the letter to the shipper.
- ▶ Only the consignee (the person or company receiving the coin changer) can file a claim against the carrier for concealed damages.
- ▶ Retain the original carton and packing materials for future use in shipping or transporting the coin changer.



Warranty

Once the unit has been inspected, record the model and serial numbers from the label on the side of the coin changer. Refer to these numbers when you call Mars Electronics for service or information. The manufacturer's warranty is based upon the date of manufacture. Parts and labor are included for In Warranty repairs.

The first three digits of the serial number contain the manufacturing date code. (See *Serial Number Configuration* on page 3.) This code indicates the beginning of the warranty period. The first two digits indicate the week of manufacture; the third digit indicates the year of manufacture. For example: a coin changer with a serial number of 42620033333 was manufactured in the 42nd week of 1996 (October 1996).

Installation

Install the Series 4000 Coin Changers using the standard mountings found in most vending machines.

1. Turn off the power to the vending machine.
2. Position the mounting holes over the mounting studs/screws in the vending machine (Figure 1).

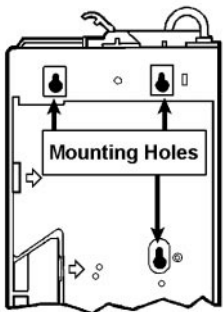

Figure 1

3. Tighten the upper right mounting screw through the access hole.
4. If you need to tighten other mounting screws, follow Steps 5 and 6. Otherwise, go to Step 7.
5. Remove the coin cassette if needed (Figure 2). Loosen the fixing screw (Figure 3) above the keypad until it is possible to tilt the acceptor assembly forward (Figure 4). The remaining mounting holes are now accessible. Tighten the screws as needed.

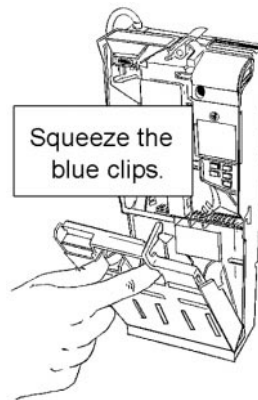

Figure 2

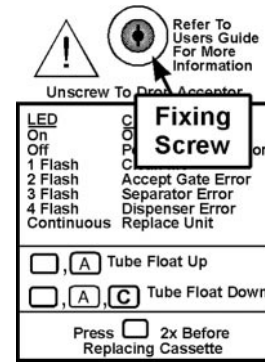

Figure 3

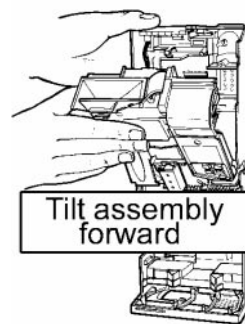

Figure 4

6. Return the acceptor assembly and tighten the fixing screw.
7. Set the option switches (Figure 7) as desired. For more information, see *Setting the Option Switches* on Page 6.
8. Connect the changer to the vending machine and turn on the power.

9. If the coin cassette is not installed on the Changer, continue with these instructions; otherwise go, to step 10.

Note: Do *not* remove power from the vending machine during this procedure.

- a. Remove the tube cassette from the box.
- b. Locate the Tube Cassette Options label (Figure 5) on the side of the new cassette. On the keypad, press and hold the Mode (yellow) button for 2 seconds (the LED will begin to flash). Enter the 3 letter code from the label. The LED will cease to flash.

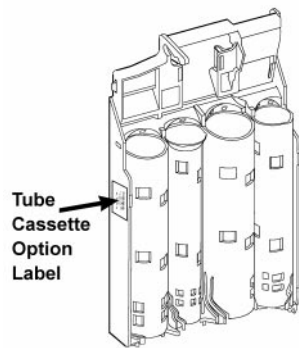
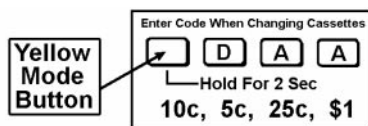

Figure 5

Example: Tube Cassette Option Label



- c. On the keypad, press the Mode (yellow) button twice to re-home the dispense mechanism.

- d. Install the new coin cassette. Align the bottom first (Figure 6), then ensure that the blue clips lock into position.

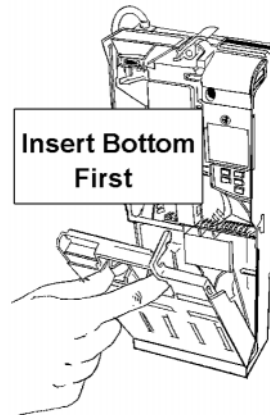

Figure 6

Note: If the Tube Cassette Label is missing, refer to the CROSS REFERENCE TABLE on page 6.

10. Ensure the reject lever operates normally, without interference. If the reject lever does not operate normally, contact the vending machine manufacturer.

The installation is now complete. If you want to fill the coin cassette, see the section entitled *Loading the Cassette* on Page 8.

Note: In some machines, you may need to dress the harness wires around the coin changer to prevent the sharp assembly edges in the vending machine from damaging the harness casing and wires.



Table 1

	TUBE POSITION			
	A	B	C	D
DAA	10¢	5¢	25¢	\$1
DAB	5¢	5¢	10¢	\$1
DAC	10¢	5¢	\$1	\$1
DAD	5¢	5¢	25¢	5¢
DBA	10¢	25¢	25¢	5¢
DBB	5¢	25¢	25¢	\$1
DBC	5¢	25¢	\$1	\$1
DBD	5¢	25¢	25¢	25¢
DCA	5¢	5¢	\$1	\$1
DCB	5¢	5¢	25¢	25¢
DCC	5¢	5¢	10¢	25¢
DCD	5¢	5¢	5¢	\$1
DDA	10¢	5¢	10¢	5¢
DDB	5¢	5¢	25¢	\$1
DDC	10¢	25¢	10¢	5¢
DDD	<i>Uses factory defined configuration</i>			

Switch Setting Configuration

The VN4000 Series product can be manually configured using a bank of eight option switches located behind the coin tube cassette.

Factory Configuration

The Series 4000 Coin Changer is factory configured with all switches in the OFF position. The following configuration is programmed:

VN4000 and VN4010XV

- Accept \$1.00 coin.
- \$1.00 coin tube to fill to the high level.
- 25¢ coin tube to fill to the high level.
- "Best Change" is enabled.
- "Tube Emulation" is enabled.
- Reject Cashbox coins.
- Accept \$1.00 coin if 25¢ tube is low.

VN4510

- Accept \$1.00 coin.
- \$1.00 coin tube to fill to the high level.
- 25¢ coin tube to fill to the high level.

The unit will default to these selections whenever all option switches are OFF. Placing switch 8 ON will override the factory settings and the coin changer will operate according to the switch settings you choose.

Switch Settings

The Series 4000 allows configuration of user options through option switch selection. The option switches are located on the coin changer behind the coin tube cassette (see option switch / label location in Figure 7). The next two pages describe how the option switches function.

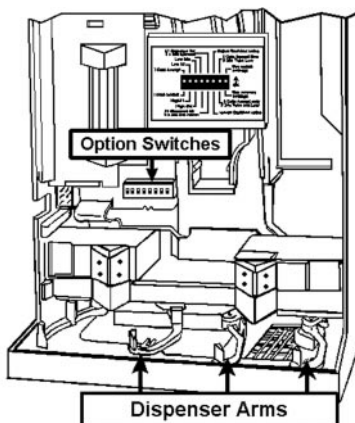

Figure 7



Setting the Option Switches

(located behind coin cassette)

- For the VN4000 or VN4010XV (MicroMech interface: 12 pin - 110v; 15 pin - 24v), see OPTIONS SWITCH SETTINGS A.
- For the VN4510 (MDB interface: 6 pin), see OPTION SWITCH SETTINGS B. (See Fig. 7 on Page 6 for the location of the option switches in the changer).

Option Switch Settings A: VN4000 or VN4010XV

Switch 1	ON	Accept \$1 coin.
	OFF	Reject \$1 coin.
Switch 2	ON	\$1 coins fill to low coin level; then are stored in cashbox.
	OFF	\$1 coins fill to upper coin level; then are stored in cashbox.
Switch 3	ON	25¢ coins fill to low coin level; then are stored in cashbox.
	OFF	25¢ coins fill to upper coin level; then are stored in cashbox.
Switch 4	-----	See Table 2 below.
Switch 5	-----	See Table 2 below.
Switch 6	ON	Reject cashbox coins.
	OFF	Accept cashbox coins.
Switch 7	ON	Accept \$1 coins regardless of the level of 25¢ coins in the tube.
	OFF	Accept \$1 coins only when the low 25¢ sensor covered.
Switch 8	ON	Option switches are in use.
	OFF	Option switches are ignored. Factory default settings are enabled if all switches (1-8) are in the off position (see default explanation on page 6).

Table 2

Switch 4 (Best Change)	Switch 4 (Emulation)	Comment
OFF	OFF	Setting for VN4010XV only on a machine with a \$1 coin payout line. Cassette must have 5¢, 10¢, 25¢, \$1 tubes.
ON	ON	All VN4000 and other VN4010XV configurations must use this setting.

Option Switch Settings B - VN4510 (MDB)

Table 3

Switch 1	ON	Accept \$1 coin.
	OFF	Reject \$1 coin.
Switch 2	ON	\$1 coins fill to low coin level and then are stored in cashbox.
	OFF	\$1 coins fill to upper coin level and then are stored in cashbox.
Switch 3	ON	25¢ coins fill to low coin level and then are stored in cashbox.
	OFF	25¢ coins fill to upper coin level and then are stored in cashbox.
Switches 4-7	NOT USED	
Switch 8	ON	Option switch settings are in use.
	OFF	Option switch settings are ignored. Factory default settings are enabled if all (1-8) switches are in the "off" position (see default explanation on page 6).

Loading the Coin Cassette

You can load the coin cassette using any of these three techniques:

- Manually, by removing the cassette
- Manually, from the front
- With the Float Up feature (see page 11):

Loading Manually by Removing Cassette

1. Remove the cassette.
2. It is recommended that you fill each tube (nickel, dime, quarter, and dollar) with at least 15 coins.

Note: Do not fill above the MAX FILL line.

Loading Manually from the Front

1. Squeeze the blue clips in front and pull the top of the cassette out until the hook on the cassette catches (see Figure 8).
2. From the front, manually load the coins into tubes B, C, and D. For tube A, push the bottom of the fill flap in and load the coins into the tube from the top of the fill flap (see figure 8).

Note: Do not fill above the MAX FILL line.

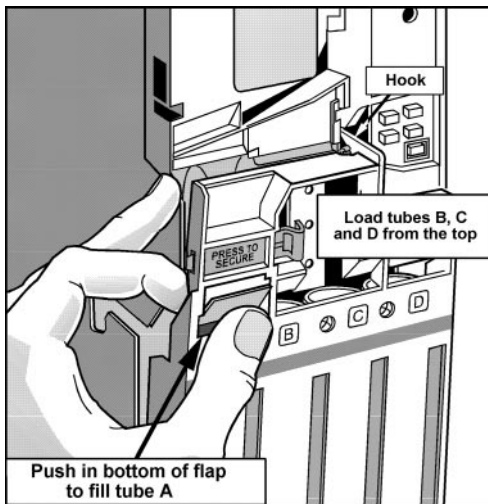

Figure 8

Loading with the Float Up Feature

When you load with the float up feature, the coin changer keeps an exact account of the number of coins in each tube.

1. Locate the Mode (yellow) button on the keypad. Press and hold the Mode button until the red LED begins to flash.
2. Release the Mode button and press the A button. The LED flashes quickly. The changer is now in float mode.
3. Insert the coins into the acceptor at the top of the changer. You must enter a **minimum of two coins** in each tube, to assure dispenser reliability. For **optimum performance**, cover the lower sensors (at least 15 coins per tube). The coins will be accepted and routed to their respective tubes.

Note: The coin changer will automatically reject coins when the upper limit is reached.

4. When you are finished, press the A button to return to normal mode.

Placing the Coin Cassette Back into Coin Changer

When you replace the coin cassette, you must first make sure that the dispenser arms at the bottom of the unit are in the correct position (see Figure 7 on Page 6).

To put the dispenser arms in the correct position:

1. Press the Mode (yellow) button twice.
2. Replace the coin cassette.
3. The tips of the dispenser arms should be visible in tubes B, C, and D.

Manually Dispensing Coins

In normal mode, the A, B, C, D keys on the keypad refer to the four tubes. To dispense a coin from a tube, press the appropriate blue key, for a single dispense.

For "latched" dispense, hold down one key for a few seconds, then release. The coins will rapidly pay out until depletion or until any key is depressed.

Testing the Changer

After installing, powering up and loading coins into the changer, it will be necessary to test the unit for basic function.

- Insert one of each denomination coin.
- Ensure that coins are routed to the proper tubes and, if applicable, coins without tubes are routed to the cashbox.
- Make a vend that requires change payback.
- Make sure the proper change is paid back.
- Press each payout button and observe that one coin is dispensed from each tube or press the mode (yellow) button twice and observe each tube dispense one coin.

After installing, powering up and loading coins into the changer it will be necessary to test the unit for basic function.

- Insert one of each denomination coin.
- Ensure that coins are routed to the proper tubes and, if applicable, coins without tubes are routed to the cashbox.
- Make a vend that requires change payback.
- Make sure the proper change is paid back.
- Press each payout button and observe that one coin is dispensed from each tube or press the mode (yellow) button twice and observe each tube dispense one coin.

General Operation

When coins are inserted into the Series 4000 changer, they pass two electronic sensors that measure coin diameter, material and thickness.

These measurements are sent to the microprocessor where they are compared with predetermined coin acceptance parameters.

If the coin measurements are outside the parameters, the accept gate remains closed and the coin is rejected. If the measurements are within the parameters, the coin is accepted. The accept gate opens and the coin travels past the strobe sensor which signals the central processor to transmit the credit to the Vending Machine Controller (VMC). At this point the coin enters the separator. The separator will route the coin to the proper coin tube or the cashbox, depending on the level of coins in that particular tube. Along with the credit, the changer transmits other information to the VMC as well. This information will be discussed in the Interface Section on page 12.

Once a vend has been completed, the VMC must calculate the change due back to the customer and transmit that amount to the changer. The changer then pays back coins from the change tubes.

Keypad Operation

The keypad is made up of four blue buttons (labeled A, B, C, and D) and one yellow button (mode). The keypad has several functions and will be discussed here.

Manual Dispense:

- Blue buttons correspond to the letters on the top of the tubes.
- Momentary press of a button releases one coin.
- Press and hold button for 3+ seconds; then release will latch the dispenser. Coins will continuously dispense until the tube is nearly empty, or another button is pressed.

Homing The Dispensers:

- If the cassette is fitted, press the Mode (yellow) button twice.
- If the cassette is not fitted, press any button.

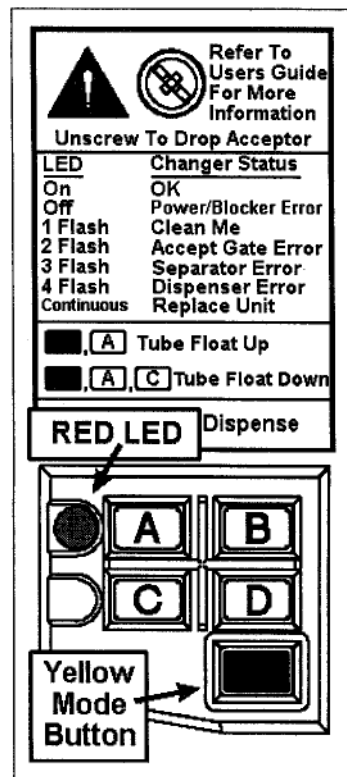

Figure 9



Shifted Functions

(using the yellow Mode button)

Notes: The shifted mode must be entered by pressing the yellow button for two seconds. Observe that the red LED will begin to flash.

Once in the shifted mode, if no further button is pressed, the shifted mode will 'time-out' in 15 seconds and the changer will return to the normal mode.

Any special function mode is exited automatically if no button is pressed or coin inserted for 45 seconds. If this happens, any changes will be abandoned.

Float Up

- Press the mode button until the LED starts to flash, then press A.
- Insert tube coins through the validator.
- Coins will be routed to the tubes but will not be reported to the vending machine.
- Full levels are:

5¢ = 70

10¢ = 102

25¢ = 70

(If dip switch 3 is 'on', 25¢ stops at the low sensor)

\$1 = 54

(If dip switch 2 is 'on', \$1 stops at the low sensor)

- Press Mode button or A to exit float mode.

Float Down

- Press Mode button until the LED flashes. Press A, then B.
- 25¢ and \$1 coins are dispensed from the tubes until a predefined count is reached.
- This count is predefined at the factory and, as of this printing, it is 10 x 25¢ and 10 x \$1 coin. The 5¢ and 10¢ tubes, if present, will remain at current levels.
- The lowest level to which the 25¢ and \$1 coins will dispense depends on the High/Low DIP switch.

Coin Teach

In the unlikely event that the changer will need to have the coin parameters re-taught, follow these steps to quickly re-teach only the coin(s) that need calibration.

Table 4

Coin	Button Sequence
5¢	MODE C A
10¢	MODE C B
25¢	MODE C C
\$1	MODE C D

- Choose the coin you wish to re-calibrate and follow button sequence from table 4 (above). (Remember to hold the mode button for 2 seconds).
- Insert 20 examples of required coin into the acceptor (the coins will be rejected).

NOTE: Be careful to insert the relevant coin.

- The 21st coin will be accepted and the LED will stop flashing. Changer will return to the normal mode.

Repeat the process for other coins.

Token Teach Feature

(VN4510 Only)

The VN4510 - MDB Coin Changer includes a Token Teach feature, which allows you to program the changer to accept up to two types of tokens that will be reported as such to the vending machine controller.

Up to two tokens may be taught.

To program tokens (Labeled token A and token B):

- Enter the token teach mode.
 - Press the mode button for two seconds (the red LED starts to flash slowly).
 - Press B + A (for token A), or Press B + B (for token B) (LED flashes faster).
- Insert 20 tokens. LED will stop flashing for approximately 2 seconds as each coin is inserted.
- After 20 tokens, the LED will stop flashing.
- Token teach is complete.



The Vending Machine will control whether or not to accept the token. The token would typically be accepted for a free vend.

Token Teach is not available on the MicroMech (VN4000 / VN4010XV) interface.

Coin Inhibit / Enable

This feature allows the user to inhibit (or re-enable) a particular coin.

- Select the coin you wish to Inhibit / Enable from table 4 (above). Use the same button sequence for the desired coin as you would to teach.
- By pressing the coin return lever, you toggle the inhibit status. For example, by pressing MODE, C, B you enter the 10¢ teach function. If the 10¢ coin is currently enabled to accept, then pressing the return lever will inhibit the coin. Or... If the 10¢ coin is currently inhibited, then pressing the return lever will enable the coin.

NOTE: There is NO visual feedback as to whether a coin is enabled or inhibited.

GENERAL

The interface of a coin changer refers to the transfer of electronic data to and from the coin changer and the Vending Machine Controller (VMC). The VMC controls all aspects of the vending machine.

The changer's role in the vending machine is to validate and accept legal coins and transmit credit and change availability to the VMC. Also, the changer will receive commands from the VMC as to how much change to pay out of the change tubes. The VMC will always decide whether or not to take coins. Product pricing is controlled by the VMC. The signals transferred to the coin changer are control signals which may include:

- the VMC is ready to accept money
- the denominations of coins to accept
- await the status of the change tubes (availability of change)

The following interfaces are available with the Series 4000 Coin Changers.

MicroMech -- 110VDC / 24VDC

This interface is available with the VN4000 (110VDC) and VN4010XV (24VDC).

The power plug pin connectors for the MicroMech are shown in Figure 10. Also shown in Figure 11 is an example of the interface logic between the MicroMech Changer and a Vending Machine Controller (VMC).

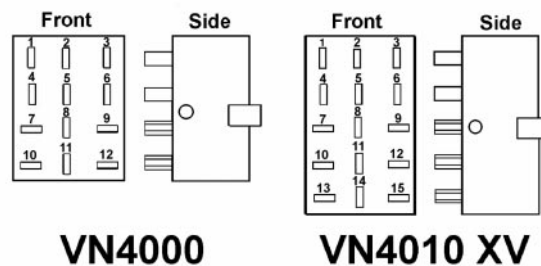

Figure 10

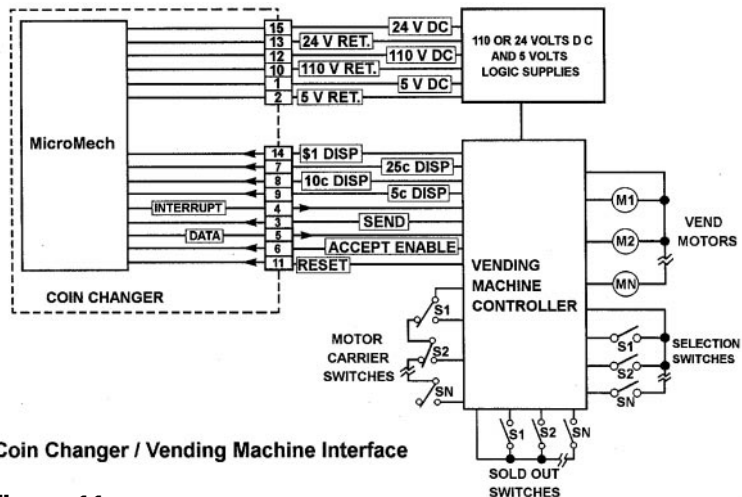

Figure 11

MicroMech Interface -- 110VDC

The Micromech interface transmits data to the Vending Machine Controller (VMC) via its INTERRUPT and DATA lines. The VMC responds to these messages via its SEND line. These three lines form the serial data link between the changer and the VMC. The VMC supplies power to operate the changer via its four power lines. In addition, the VMC has five or six* control lines that authorize coin payout, enable/inhibit coin acceptance, and reset the changer to its standby condition.

* The sixth line on 24 volt controllers may or may not support \$1 coin payout.

The following is the sequence of operations in the Micromech electronics:

- ✓ When a coin enters the mechanism, an "interrupt" signal is sent on Pin #4 to inform the VMC that the mechanism is ready to send credit information.
- ✓ When the VMC receives this "interrupt" signal, it signals the mechanism via a "send" signal on Pin #3. This indicates to the mechanism that the controller is ready to accept "data".
- ✓ When the mechanism receives this "send" signal, it transmits a message on Pin #5 containing the following data:
 - coin value - 5¢, 10¢, 25¢ or \$1.00
 - coin tube status - low level sensors are covered/not covered
 - coin route - to coin tube or to cash box
- ✓ If a coin is rejected, or there is a problem in the mechanism, certain default messages are sent to the VMC on the "data" line. They are as follows:
 - Slug: coin entered but was not accepted (accept gate did not open)
 - No Strobe: coin was accepted but did not actuate strobe (could indicate jam or defective strobe)
 - Dollar coins rejected due to insufficient quarters in the coin tube
 - Defective sensor in the coin tube

- Power up - indicates coin changer was just reset or powered up

When sufficient credit has been established in the VMC to enable a vend, the VMC performs the changemaking logic and sends logic +5V signal(s) to operate the appropriate 5¢, 10¢, 25¢, and \$1* dispenser commands to the Coin Changer for change (if needed).

* If \$1 coin is supported.

Two special features include:

- ✓ Whenever the VMC sends the "accept enable" signal on Pin #6, the mechanism sends the "coin tube status" message. This can be used while dispensing quarters to see when the coins uncover the lower sensor. When the lower sensor is uncovered, the changer will still be able to dispense four more coins from that tube.

It can also be used by the controller to determine if the mechanism is operating by sending the "accept enable" message every so often when no transaction has taken place.

- ✓ Reset (Line #11) - this line enables the controller to reset the microprocessor of the mechanism in the event there is a low power condition on the 5 volt line.

Power Plug Pinouts - 12 Pin

Pin #	Function
1	5VDC supply (positive)
2	5VDC supply return
3	Send (0v active)
4	Interrupt (0v active)
5	Data (0v active)
6	Accept Enable (0v active)
7	25¢ Dispense (0v active)
8	10¢ Dispense (0v active)
9	5¢ Dispense (0v active)
10	117 VDC supply return
11	Reset (+5 VDC active)
12	117 VDC supply positive (rectified un-filtered)

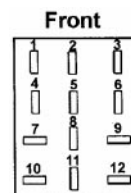

MICROMECH INTERFACE (15-pin)

The 15-pin Micromech interface is a duplicate of the 12-pin Micromech interface with two exceptions:

- 1) Pin #14 will utilize Dollar coin dispense. Please note that this may not be utilized on all vending machines. Check with the manufacturer of the vending machine for more information.



2) Pins 10 and 12 are not used; 24 VDC can be sensed on pins 13 and 15.

Power Plug Pinouts - 15 Pin

Pin # Function

- 1 5VDC supply (positive)
- 2 5VDC supply return
- 3 Send (0v active)
- 4 Interrupt (0v active)
- 5 Data (0v active)
- 6 Accept Enable (0v active)
- 7 25¢ Dispense (0v active)
- 8 10¢ Dispense (0v active)
- 9 5¢ Dispense (0v active)
- 10 120 VDC supply return
- 11 Reset (+5 VDC active)
- 12 120 VDC supply positive (rectified un-filtered)
- 13 24 VDC supply return
- 14 \$ Coin Dispense (0v active)
- 15 24 VDC supply positive (rectified un-filtered)

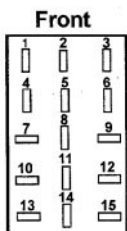

This interface uses the application of a specific bi-directional serial interface protocol for communication between a Vending Machine Controller (VMC) and a Coin changer.

The Coin Changer:

- Is under complete control of the VMC.
- On power up, the changer reports the coin types and values, the decimal point position, and what tubes are available for change payback.
- The VMC polls the changer.
- As the changer accepts coins, it reports the coin information to the VMC.
- After the vend, the VMC will command the changer to pay back any change due.

All coin tubes are monitored for the presence of change in order to determine if an exact change condition exists. This information is transmitted to the VMC each time the VMC asks. The VMC will decide if and when to turn "ON" the exact change light. The VMC will also decide when to enable the bill acceptor, if applicable.

Note: This changer supports both level 2 and level 3 Multi-Drop Bus Interface as written in the National Automatic Merchandising Association (NAMA) International Multi-Drop Bus Interface Standard.

MDB - MULTI-DROP BUS (24 to 34 Volts dc)

This interface is available with the VN4510

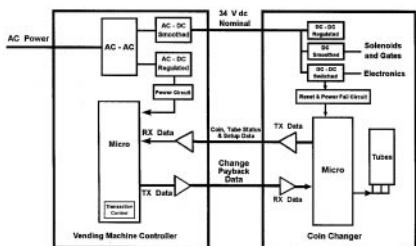

Figure 12



Cleaning

For trouble free operation, develop a routine maintenance schedule and periodically clean the acceptor in the areas shown in Figure 13.

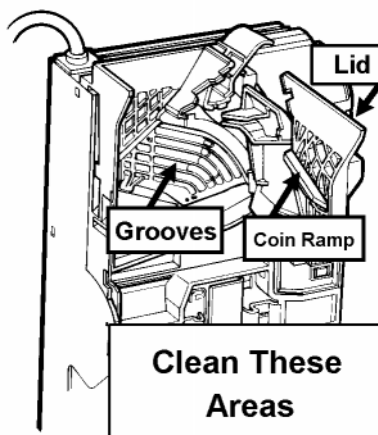

Figure 13



You can clean the Coin Changer while it is still mounted in the machine (refer to Figure 13 on page 14).

1. Remove power from the Coin Changer.
2. Open the acceptor lid as shown in Figure 13. (Lid will stay in the open position)
3. Use a damp cloth with a mild detergent to clean the Groove, Coin ramp and Lid areas indicated.
4. Ensure that the accept gate area (below the lid when closed) is clear and not jammed with debris.
5. Close the lid
6. Turn "on" power and test.

Diagnostics

General

The Series 4000 coin changer product is designed to be relatively simple to repair in the field using a "Module Swap" philosophy. The Status LED located on the keypad will assist in pinpointing the general location of a problem.

Status LED

The LED, located on the keypad, provides an indication of the coin changer status and provides assistance in diagnosing the condition of the Series 4000. Note any problems that occur when the LED pulses one or more flashes, followed by a pause, and then repeats. The following is a description of the LED codes, their meanings, and suggested remedial actions.

Signal	Meaning	Solution
LED ON	Indicates that the changer is enabled and ready to operate.	No action necessary.
LED OFF	Indicates that no power has been applied to the changer or the vendor has an error.	Check to ensure that power is applied. Check that the vendor is in proper working order.
1 Flash	Indicates that the changer requires cleaning.	Refer to "Cleaning the acceptor" on page 14.
2 Flashes	Changer senses an error in the accept gate area.	Usually an obstruction of the strobe sensor. Refer to "Diagnostics - Acceptor" on page 16 to clear.
3 Flashes	Changer senses an error in the separator.	This error occurs when one of the "top of tube" sensors remains covered for an extended period of time. Refer to "Diagnostics - Separator" on page 17 for assistance.
4 Flashes	Changer senses an error in the dispenser area.	This error occurs when the dispenser is not completing full dispense-cycles. A jammed or bent coin could be the cause. Refer to "Diagnostics - Dispenser" on page 17 for further information.
5 Flashes	Changer has sensed water damage. Unit may have shut down.	Unit may require extensive cleaning. Return unit for service.
Continuous Flash	Remove unit and return for service.	Replace the unit.

Diagnosing and Repairing by LED Signals

When performing any type of repair, it is strongly recommended that the power be removed from the Changer.

LED Flash 1 - See Cleaning the acceptor in the Maintenance Section on page 14.

LED Flash 2 - Acceptor

Flash code number 2 is an indication of a blockage in the Strobe Sensor. To check and possibly clear this error, follow these instructions:

1. Remove the Cassette.
2. Loosen the 'fixing screw' above the keypad until it is possible to tilt the acceptor forward.
3. Lift the acceptor up and out, then disconnect the gray 26-way ribbon connector.
4. Turn the acceptor assembly over and locate and disconnect the 7-way ribbon connector.
5. Also, disconnect the two multi-colored wire connectors next to the 7-way ribbon connector. See Figure 14.

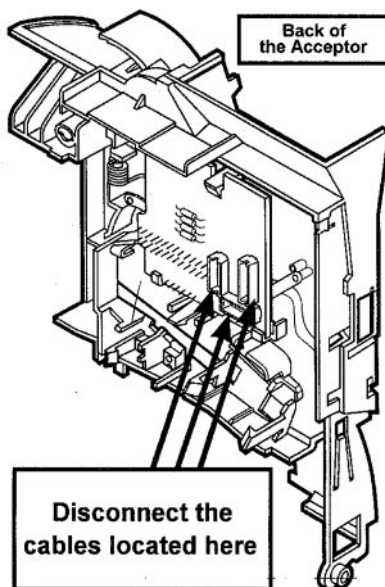

Figure 14

6. Un-thread the ribbon and the two multi-colored wires. It is now possible to remove the separator from the acceptor.
7. Looking at the front of the acceptor, locate the clips on the left side and gently pry these clips until it is possible to un-hinge the separator from the acceptor. See Figure 15.

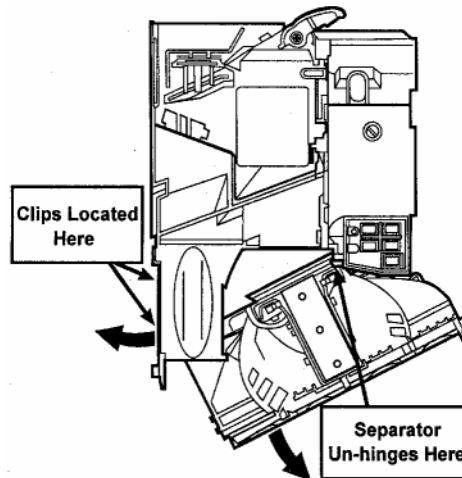

Figure 15

8. Once the separator has been removed from the acceptor, there is access to the coin accept slot. The sensor that detects a jam is located just above this opening. See Figure 16. Clear any debris/coins from this area.

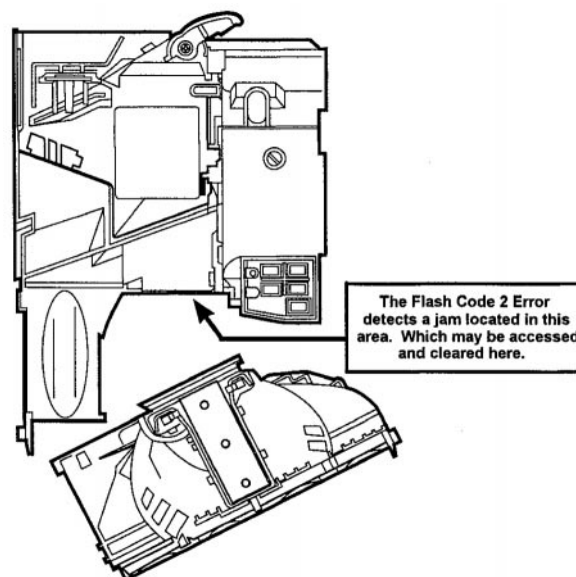

Figure 16

9. Re-assemble the changer. Take care to route the three separator cables to their proper places.

Flash Code 3 - Separator

Flash code number 3 is an indication that one (or more) of the four "top of tube" sensors is blocked. These sensors are located at the very bottom of the separator (see Figure 17) and line up just above each tube. The sensor matches with a reflective prism which is located in the Tube Cassette just above each tube (see Figure 17).

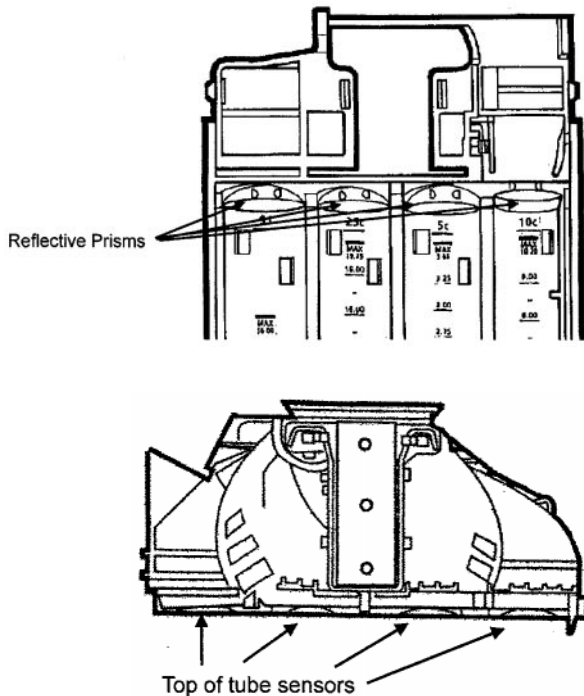

Figure 17

To correct this error, remove the tube cassette and clear any coins that are jammed in the top of the tube or the bottom of the tube exit slot on the separator.

Flash Code 4 - Dispenser

Flash code number 4 is an indication of a jam in the dispenser area. The dispenser area (see Figure 18) is at the very bottom of the changer.

1. To correct this error, remove the tube cassette and clear any jammed coins
2. Verify that the bottom coin in each tube is not bent or deformed.

3. With the cassette removed, depress any blue key to cycle all four of the dispenser arms and clear the error.
4. Place the cassette back into the changer.

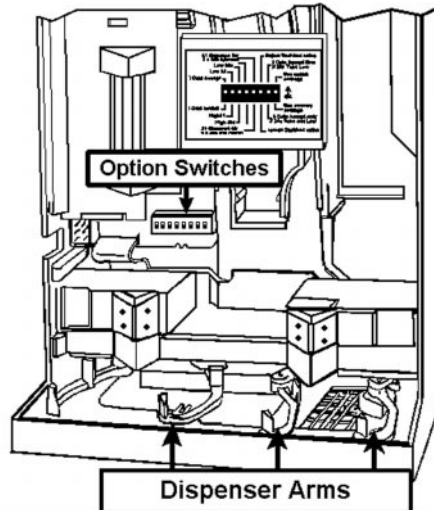

Figure 18

!!!! WARNING !!!!

To avoid a possible shock hazard, use care when performing any procedure that involves installing the Control Board/Backplate Assembly. Route the Main Harness and Dispenser Harness wires in such a way that they cannot be pinched between the Backplate and Housing.

Note: Check changer acceptance whenever the Acceptor/Gate Assembly is replaced. If acceptance is satisfactory, calibrate the unit by inserting 15 coins of each denomination. If acceptance is poor, tune and coin teach the unit following the instructions on page 11.



NOTES:

Series of horizontal lines for taking notes.