

Hamilton Manufacturing Corporation

1026 Hamilton Dr. Holland, OH 43528 • Phone: 419-867-4858/800-837-5561 • Fax: 419-867-4867 • www.hamiltonmfg.com

Operational Manual for the HS/HSC Changer

TABLE OF CONTENTS

I. INSTALLATION	4
MOUNTING	4
ELECTRICAL	4
II. MAINTENANCE	5
HOPPER	5
VALIDATOR	5
STACKER	5
CONTROLLER	5
III. PARTS	6
<i>APPENDIX A</i>	<i>8</i>
2 HOPPER MODE	8
3 HOPPER MODE	11
<i>APPENDIX B</i>	<i>12</i>
<i>APPENDIX C</i>	<i>13</i>

ABOUT THIS MANUAL

This manual will provide the operator with important information about installing and maintaining the HS-2, HS-3, HSC-2, or the HSC-3 Changer. General information is provided for the Hopper, Validator, Stacker, and Controller. However, if additional information is needed for these components, please refer to the appropriate manual. To obtain assistance from the manufacturer, please call (800) 837-5561 or (419) 867-4858.

When calling for assistance, it is very important to have serial numbers readily available. Please take the time to record these numbers in the spaces provided. Note that models HS-2 and HSC-2 have two Hoppers, and that models HS-3 and HSC-3 have three Hoppers.

HS-2/HS-3, OR HSC-2/HSC-3

CHANGER SERIAL # _____

VALIDATOR SERIAL # _____

HOPPER 1 SERIAL # _____

HOPPER 2 SERIAL # _____

HOPPER 3 SERIAL # _____

STACKER SERIAL # _____

CONTROLLER SERIAL # _____

KEY / LOCK # _____

Please complete the warranty card, which was included with your changer, and return it to the manufacturer.

I. INSTALLATION

MOUNTING

Cabinets are pre-drilled for wall mounting or mounting on an optional base. Bases are pre-drilled for securing to the floor. Do not use leveling screws when fastening to the floor. Changers mounted on bases should be securely fastened to both the floor and the wall. Fasteners to be used should be recommended by your engineer as to strength and suitability for floor and wall composition. Hamilton will not be responsible for injury due to improper installation.

For mounting in wall, cabinet size is 41- 3/8" H x 20" W x 12- 7/8" D.

ELECTRICAL

This currency changer is operated on 120VAC, 60Hz. This changer uses a 6 AMP CIRCUIT BREAKER for use with two Hoppers, and an 8 AMP CIRCUIT BREAKER for use with three Hoppers. Unit may be hard-wired with conduit if desired.

A GROUND FAULT INTERRUPTER IS REQUIRED. The recommended Ground Fault Interrupter should have the following specifications:

- **120VAC**
- **15 AMP**
- **6-10mA trip level**
- **Should not trip when power is removed from circuit.**

II. MAINTENANCE



CAUTION! Do not use oil, grease or solvents on any part of this changer except as clearly specified in this manual, the hopper manual, the validator manual or in the stacker manual.

HOPPER

Any lubrication in the Hopper can result in a faulty payout. Empty the coins from the Hopper and vacuum once a month. Use a soft brush to loosen dirt. Refer to the Hopper Manual for details on maintenance.

VALIDATOR

Refer to the Validator Manual for lubrication instructions and all other information. **THE VALIDATOR SHOULD BE SERVICED ANNUALLY TO MAINTAIN MAXIMUM PERFORMANCE. ONLY A TRAINED TECHNICIAN SHOULD DO THIS WORK.**

STACKER

Refer to the Stacker Manual for information regarding maintenance.

CONTROLLER

The microprocessor based Hamilton C2000 Controller monitors the systems of the HS-2/HS-3 and the HSC-2/HSC-3 Bill Changers. If a problem is detected, the Controller will shut the machine down and display the appropriate error code. Refer to the C2000 or Audit Pro Controller Manual for error codes.

The twelve DIPswitches located near the Computer Reset Button select the payback of coins on multi-Hopper change units. There is no need to change the switch settings on a typical Model HS-2/HS-3 or HSC-2/HSC-3 Changer, as they are set to the payout arranged when the order was placed with Hamilton. Included in the C2000 manual are sheets listing the switch settings of most typical payout arrangements for your particular model Changer. Please remember that the Coin Hoppers may not have the proper Coin Wheel if changing the coin type you are vending. These switches are to remain in the positions set at the factory unless you are not satisfied with the current payout setting. If none of the included standard settings meet your wishes, contact Hamilton for assistance. **YOU MUST HAVE THE CONTROLLER MODEL NUMBER READY.**

III. PARTS

PART #	DESCRIPTION	QTY
46-4000	XE VALIDATOR	1
36-0036	SINGLE STACKER	1
	OR	
35-0100	DUAL STACKER	1
	OR	
48-2115A	HARNESS, DUAL STACKER / HV-X EXTENSION	1
49-2000A	MAIN CONTROLLER, C2000	1
	OR	
49-2004A	AUDIT PRO CONTROLLER	1
49-2010A	AUDIT PRO REMOTE	1
49-1022B,C	POWER BOX, 8 AMP (3 HOPPER), 6 AMP (2 HOPPER)	1
11-0100	QUARTER HOPPER	* 2 - 3
11-0100B	DIME HOPPER	* 2 - 3
11-0100A	NICKEL HOPPER	* 2 - 3
11-0100D	.800 TOKEN HOPPER	* 2 - 3
11-0100E	1-1/8" TOKEN HOPPER ASSEMBLY	* 2 - 3
11-0100F	GOLD DOLLAR HOPPER	*2 - 3
80-0035	COIN ACCEPTOR COINCO, NS	1
90-0275	LOCK BOLT 1/2 - 13 X 1"	2
90-0336	LOCK NUT, SPRING LOADED	2
60-0048	COIN CUP, ROUNDED H.D.	1
60-0029	COIN BOX CSA, HSC-3	1
48-1008	HS-3 / HSC-3 HARNESS	1
80-1100A	PCB ASSEMBLY, COINCO III	1
47-0217	LINE CORD, EXT.	1
60-0082	COIN ENTRANCE CHUTE CM3-C-S	1
80-0036	HOUSING, COINCO ACCEPTOR, NS	1
60-0046	COIN RETURN FLIPPER CM3/HS-3	1
11-0033	HOPPER PIVOT BRACKET	** 2 - 3
60-0115	VALIDATOR BRACKET, NS	1
60-0117	HS-3 VALIDATOR SUPPORT BRACKET	1
60-0131	COIN MECH BRACKET HSC-3	1
60-0118	DUAL STACKER VALIDATOR BRACKET	1
60-0061	FLIPPER, ROUNDED COIN CUP	1
61-0510A	CABINET COMPLETE, HS-3	1
	OR	
61-0510C	CABINET COMPLETE, HSC-3	1
	OR	















PART #	DESCRIPTION	QTY
61-0510E	CABINET COMPLETE, HS-2	1
	OR	
61-0510G	CABINET COMPLETE, HSC-2	1
63-0408A	FACE PANEL ASSEMBLY HS-2 & HS-3	1
60-0006B	ASSEMBLY, FACEPLATE VALDE S. STEEL	1
47-0080	OUT OF SERVICE LAMP	1
47-0080A	SPEED NUT, TINNEMAN	1
63-5006	LOCK BARREL	2
63-5005	LOCK INSERT, ONE PAIR	1
60-0014	COIN SLOT, QUARTER	1
60-0109	CHUTE, HSC-3 COINCO III RETURN	1
60-0070A	COIN RETURN BUTTON ASSEMBLY	1
48-0051A	GROUND STRAP HARNESS	1
47-0029	CONDUIT CONNECTOR, 3/8"	1
47-0077	CHANGER GROUND TERMINAL	2
47-0200	WIRE NUT	2
48-0033A	STACKER BYPASS PLUG	1
90-0331	HEX NUT, 1/4 - 20	9
90-0333	R.H. SCREW, 1/4 - 20 x 1/2"	9
90-0403	LOCKWASHER, 1/4" INTERNAL	9
90-0327	WING NUT, 10-24	2
90-0301	NUT, 10-24 x 3/8"	4
90-0326	NYLON LOCKNUT, 10-24	4
90-0612	LOCKWASHER, #10 INTERNAL	4
90-0142	SCREW, 8/32 x 1/4"	3
90-0145	P. H. SCREW, 8/32 x 5/8"	3
90-0320	LOCKNUT 8-32	3
90-0428	WASHER, SPACER	2
90-0417	WASHER, #10 BRASS	3
90-0251	**THUMBSCREW, 10-32 x 1"	3
90-0248	THUMBSCREW, 8-32 x 3/8"	1
90-0250	MOUNTING STUD CONTROLLER, LONG	1
47-0232	PANDUIT MOUNTING PADS	18
47-0275	CABLE TIE, 6"	19

* Any combination of 2 hoppers can be used in models HS-2 and HSC-2.
Any combination of 3 hoppers can be used in models HS-3 and HSC-3.

















**Quantity varies depending on the model and the number of hoppers used in the machine.

APPENDIX A





SWITCH SETTINGS 2 HOPPER MODE

SWITCH SETTING	MODE OF OPERATION / PAYOUT OPTIONS
OFF  ON  11 ABCDEFGH IJKL	2 HOPPERS - QUARTERS, DIMES $1\$ = 4q$ $5\$ = 20q$ $10\$ = 40q$ $20\$ = 80q$ $2q = 5d$
OFF  ON  12 ABCDEFGH IJKL	2 HOPPERS - QUARTERS, DIMES $1\$ = 2q+5d$ $5\$ = 18q+5d$ $10\$ = 36q+10d$ $20\$ = 72q+20d$ $2q = 5d$
OFF  ON  13 ABCDEFGH IJKL	2 HOPPERS - QUARTERS, NICKELS $1\$ = 4q$ $5\$ = 20q$ $10\$ = 40q$ $20\$ = 80q$ $1q = 5n$
OFF  ON  14 ABCDEFGH IJKL	2 HOPPERS - QUARTERS, NICKELS $1\$ = 3q+5n$ $5\$ = 19q+5n$ $10\$ = 38q+10n$ $20\$ = 76q+20n$ $1q = 5n$
OFF  ON  23 ABCDEFGH IJKL	2 HOPPERS - QUARTERS, SBA $1\$ = 4q$ $5\$ = 4q+4s$ $10\$ = 8q+8s$ $20\$ = 4q+19s$
OFF  ON  26 ABCDEFGH IJKL	2 HOPPERS - TOKENS, TOKENS $1\$ = 1t$ $5\$ = 5t$ $10\$ = 10t$ $20\$ = 20t$ $4q = 1t$
OFF  ON  27 ABCDEFGH IJKL	2 HOPPERS - TOKENS, TOKENS $1q = 1t$ $1\$ = 4t$ $5\$ = 20t$ $10\$ = 40t$ $20\$ = 80t$

















SWITCH SETTINGS 2 HOPPER MODE

SWITCH SETTING	MODE OF OPERATION / PAYOUT OPTIONS
OFF  ON  33 A B C D E F G H I J K L	2 HOPPERS - DIMES, NICKELS $1\$ = 5d + 10n$ $10\$ = 80d + 40n$ $5\$ = 40d + 20n$ $20\$ = 160d + 80n$
OFF  ON  37 A B C D E F G H I J K L	2 HOPPERS - QUARTERS, QUARTERS $1q = 1q$ $10\$ = 40q$ $1\$ = 4q$ $20\$ = 80q$ $5\$ = 20q$
OFF  ON  40 A B C D E F G H I J K L	2 HOPPERS - QUARTERS, DIMES $2q = 5d$ $10\$ = 40q$ $1\$ = 4q$ $20\$ = 80q$ $5\$ = 20q$
OFF  ON  52 A B C D E F G H I J K L	2 HOPPERS - TOKEN, TOKEN $1\$ = 4t$ $10\$ = 45t$ $5\$ = 22t$ $20\$ = 90t$
OFF  ON  85 A B C D E F G H I J K L	2 HOPPERS - QUARTERS, NICKELS $1\$ = 3q + 5n$ $10\$ = 38q + 10n$ $5\$ = 19q + 5n$ $20\$ = 76q + 20n$
OFF  ON  87 A B C D E F G H I J K L	2 HOPPERS - QUARTERS, DIMES $1\$ = 2q + 5d$ $20\$ = 78q + 5d$ $5\$ = 16q + 5d$ $10\$ = 38q + 5d$ $2q = 5d$
OFF  ON  88 A B C D E F G H I J K L	2 HOPPERS - QUARTERS, DIMES $1\$ = 2q + 5d$ $10\$ = 38q - 5d$ $5\$ = 18q + 5d$ $20\$ = 78q + 5d$ $2q = 5d$
OFF  ON  115 A B C D E F G H I J K L	2 HOPPERS - QUARTERS, TOKENS $1q = 1t$ $10\$ = 20q + 20t$ $1\$ = 2q + 2t$ $20\$ = 40q + 40t$ $5\$ = 10q + 10t$

SWITCH SETTINGS 2 HOPPER MODE

SWITCH SETTING	MODE OF OPERATION / PAYOUT OPTIONS
OFF  ON  119 A B C D E F G H I J K L	2 HOPPERS - QUARTERS, SBA $1s = 4q$ $10\$ = 8q + 8s$ $1\$ = 4q$ $20\$ = 16q + 16s$ $5\$ = 4q + 4s$
OFF  ON  130 A B C D E F G H I J K L	2 HOPPERS - QUARTERS, NICKELS $1q = 5n$ $10\$ = 40q$ $1\$ = 3q + 5n$ $20\$ = 80q$ $5\$ = 20q$

SWITCH SETTINGS 3 HOPPER MODE

SWITCH SETTING	MODE OF OPERATION / PAYOUT OPTIONS
OFF  ON  2 A B C D E F G H I J K L 20\$ = 76q+8d+4n 5\$ = 19q+2d+1n	3 HOPPERS - QUARTERS, DIMES, NICKELS 1\$ = 3q+2d+1n 10\$ = 38q+4d+2n
OFF  ON  3 A B C D E F G H I J K L	3 HOPPERS - QUARTERS, DIMES, NICKELS 1\$ = 3q+1d+3n 10\$ = 38q+2d+6n 5\$ = 19q+1d+3n 20\$ = 76q+4d+12n
OFF  ON  6 A B C D E F G H I J K L	3 HOPPERS - QUARTERS, DIMES, NICKELS 1\$ = 2q+4d+2n 10\$ = 36q+8d+4n 5\$ = 18q+4d+2n 20\$ = 72q+16d+8n
OFF  ON  35 A B C D E F G H I J K L	3 HOPPERS - QUARTERS, QUARTERS, QUARTERS 1\$ = 4q 10\$ = 40q 5\$ = 20q 20\$ = 80q
OFF  ON  74 A B C D E F G H I J K L	3 HOPPERS - QUARTERS, DIMES, NICKELS 1\$ = 4q 10\$ = 40q 5\$ = 20q 20\$ = 80q
OFF  ON  80 A B C D E F G H I J K L	3 HOPPERS - TOKENS, TOKENS, TOKENS 1q = 1t 10\$ = 40t 1\$ = 4t 20\$ = 80t 5\$ = 20t
OFF  ON  98 A B C D E F G H I J K L	3 HOPPERS - QUARTERS, DIMES, NICKELS 1n = 2d+1n 10\$ = 39q+2d+1n 1\$ = 3q+2d+1n 20\$ = 79q+2d+1n 5\$ = 19q+2d+1n
OFF  ON  158 A B C D E F G H I J K L	3 HOPPERS - TOKENS, TOKENS, TOKENS 1\$ = 4t 10\$ = 40t 5\$ = 20t 20\$ = 100t

APPENDIX B

HS-3 / HSC-3 HARNESS

PART # 48-1008A

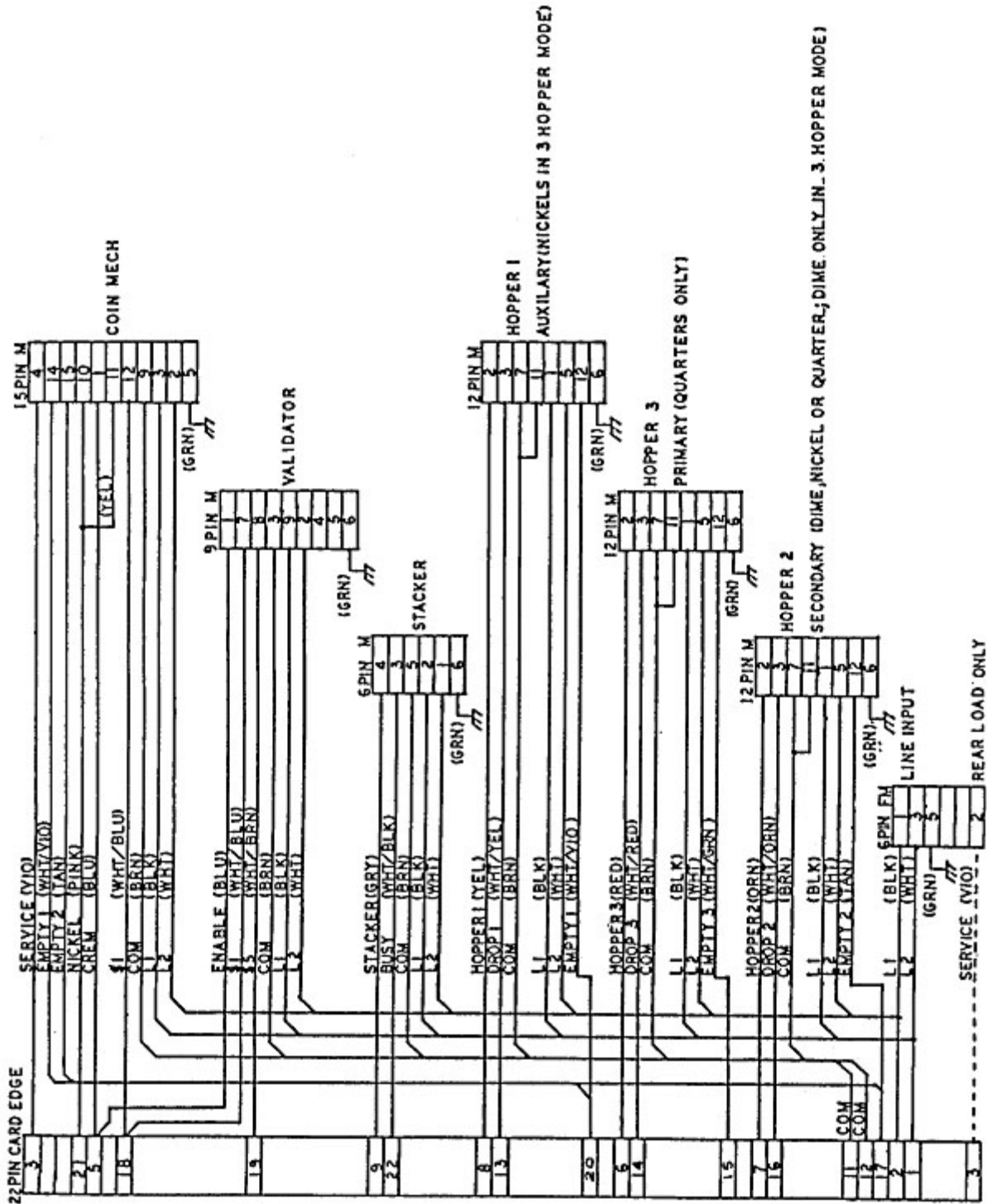

APPENDIX C

BILL DENOMINATION MYLAR INSTALLATION INSTRUCTIONS

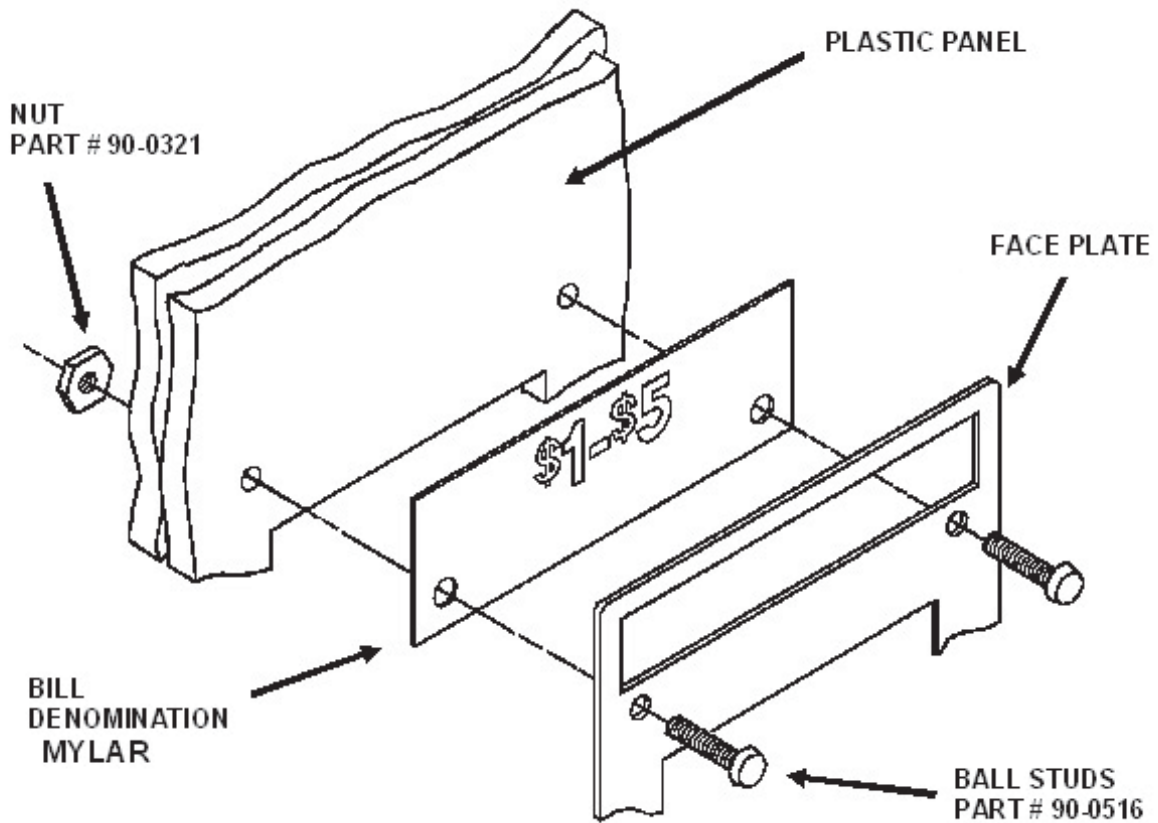

1. Loosen and remove the NUTS from the BALL STUDS.
2. Remove the BALL STUDS from the FACE PLATE.
3. Insert the BILL DENOMINATION MYLAR between the FACE PLATE and the PLASTIC PANEL until the holes in the BILL DENOMINATION MYLAR line up with the holes in the FACE PLATE.
4. Reinsert the BALL STUDS into the front of the FACE PLATE, through the BILL DENOMINATIN MYLAR and the PLASTIC PANEL.
5. Replace the NUTS on the BALL STUDS and tighten.

LIMITED WARRANTY AGREEMENT OF HAMILTON MANUFACTURING CORP.

Hamilton Manufacturing Corp., an Ohio Corporation, (“Seller”) warrants to Purchaser that all new equipment shall be free from defects in material and factory workmanship for a period of one (1) year from the original shipping date. Hamilton Manufacturing Corp. further warrants if any part of said new equipment in Seller’s sole opinion, requires replacement or repair due to a defect in material or factory workmanship during said period, Seller will repair or replace said new equipment. Purchaser’s remedies and the liabilities and obligations of Seller herein shall be limited to repair or replacement of the equipment as Seller may choose, and Seller’s obligation to remedy such defects shall not exceed the Purchaser’s original cost for the equipment. Purchaser EXPRESSLY AGREES this is the EXCLUSIVE REMEDY under this warranty. There are no other express or implied warranties which extend beyond the face hereof. All warranty repair service must be performed by either a Factory Trained Service Representative or **HAMILTON MANUFACTURING CORP., 1026 Hamilton Drive, Holland, Ohio 43528 PHONE (419) 867-4858 or (800) 837-5561, FAX (419) 867-4867.**

The limited warranty for new equipment is conditioned upon the following:

1. The subject equipment has not, in the Seller’s sole opinion, been subjected to: accident, abuse, misuse, vandalism, civil disobedience, riots, acts of God, natural disaster, acts of war or terrorism.
2. The Seller shall not be liable for any expense incurred by Purchaser incidental to the repair or replacement of equipment and Purchaser shall assume full responsibility for any freight or shipping charges.
3. The coverage of this warranty shall not extend to expendable parts.
4. Purchaser shall have a warranty registration card on file with Seller prior to any claim in order for warranty protection to apply.
5. No warranty coverage is applicable to any equipment used for currency other than that specified at the time of the purchase.
6. Seller expressly disclaims any warranty that counterfeit currency will not activate said equipment.
7. Seller expressly disclaims any warranty for any losses due to bill manipulation or theft or loss of cash under any circumstances.
8. Use of the equipment for anything other than its intended and designed use will void the Limited Warranty Agreement. Use of equipment for anything other than its intended and designed use includes, but is not limited to, downloading software/applications not certified by Seller such as e-mail, spyware, screen savers, viruses, worms, third party software, web search engines, cookies, spam, desktop applications, games, web surfing, etc.

Seller further warrants all repair or service work performed by a factory trained representative or Hamilton Manufacturing Corp. for a period of ninety (90) days from the date the repair or service work was performed. Purchaser’s remedies and the liabilities and obligations of Seller herein shall be limited to repair or replacement of equipment as Seller may choose, and Seller’s obligation to remedy such defects shall not exceed the Purchaser’s depreciated value of the equipment. Purchaser EXPRESSLY AGREES this is an EXCLUSIVE REMEDY under this warranty. There are no other express or implied warranties on repair or service work performed by a factory trained representative or Hamilton Manufacturing Corp. which extend beyond the face hereof.

The limited warranty for repair and service work is conditioned upon the following:

1. The subject equipment has not, in the Seller's sole opinion, been subjected to: accident, abuse, misuse, vandalism, civil disobedience, riots, acts of God, natural disaster, acts of war or terrorism.
2. The Seller shall not be liable for any expense incurred by Purchaser incidental to the repair or replacement of equipment and Purchaser shall assume full responsibility for any freight or shipping charges.
3. The coverage of this warranty shall not extend to expendable parts.
4. Purchaser shall have a warranty registration card on file with Seller prior to any claim in order for warranty protection to apply.
5. No warranty coverage is applicable to any equipment used for currency other than that specified at the time of the purchase.
6. Seller expressly disclaims any warranty that counterfeit currency will not activate said equipment.
7. Seller expressly disclaims any warranty for any losses due to bill manipulation or theft or loss of cash under any circumstances.
8. No person or entity other than a factory trained representative or Hamilton Manufacturing Corp. has performed or attempted to perform the subject repair or service.
9. Using equipment which has been serviced or repaired for anything other than its intended or designed use such as downloading software applications not certified by Seller will void the Limited Warranty Agreement. This includes software/applications such as e-mail, spyware, screen savers, viruses, worms, third party software, web search engines, cookies, spam, desktop applications, games, web surfing, etc.

THIS AGREEMENT IS MADE WITH THE EXPRESS UNDERSTANDING THAT THERE ARE NO IMPLIED WARRANTIES THAT THE EQUIPMENT SHALL BE MERCHANTABLE, OR THAT THE GOODS SHALL BE FIT FOR ANY PARTICULAR PURPOSE. PURCHASER HEREBY ACKNOWLEDGES THAT IT IS NOT RELYING ON THE SELLER'S SKILL OR JUDGMENT TO SELECT OR FURNISH EQUIPMENT SUITABLE FOR ANY PARTICULAR PURPOSE AND THAT THERE ARE NO WARRANTIES WHICH EXTEND BEYOND THAT WHICH IS DESCRIBED HEREIN.

The Purchaser agrees that in no event will the Seller be liable for direct, indirect, or consequential damages or for injury resulting from any defective or non-conforming new, repaired or serviced equipment, or for any loss, damage or expense of any kind, including loss of profits, business interruption, loss of business information or other pecuniary loss arising in connection with this Limited Warranty Agreement, or with the use of, or inability to use the subject equipment regardless of Sellers knowledge of the possibility of the same.

Hamilton Manufacturing Corporation

1026 Hamilton Drive
Holland, OH 43528

Sales Phone: (888) 723-4858 **Sales Fax:** (419) 867-4850
Customer Service Phone: (800) 837-5561 **Customer Service Fax:** (419) 867-4857
Parts Phone: (866) 835-1721 **Parts Fax:** (419) 867-4867

Website: <http://www.hamiltonmfg.com>

Email Addresses:

service@hamiltonmfg.com

sales@hamiltonmfg.com

parts@hamiltonmfg.com